

Effects of sound on separated flows

By JON A. PETERKA AND PETER D. RICHARDSON

Center for Fluid Dynamics, Division of Engineering,
Brown University, Providence, Rhode Island

(Received 5 September 1968)

Measurements of flow and fluctuating heat transfer were made for a circular cylinder in cross-flow with a transverse standing sound field imposed simultaneously. Reynolds numbers were of the order of 10^4 , known to be in the disturbance-sensitive range, and sound intensities were as large as 140 db. The frequencies of the sound field were of the order of the disturbance frequency in the separated shear layers, reported first by Bloor.

With a sound field having its frequency matched sufficiently closely to that occurring naturally in the shear layer, the growth of the instability is enhanced with the processes of vortex fusion and possibly vortex breakdown being detectable. At the same time, the vortex street frequency is only very weakly affected, although the vortex formation region length is reduced when the instability in the shear layer is enhanced. It is suggested that the discretization of vorticity in the shear layers is one factor significant in reducing the formation length. Heat transfer at the rear of the cylinder fluctuates at frequencies centred on the shedding frequency. The fluctuation level increases as the formation region shortens.

1. Introduction

The flow around a circular cylinder with its axis transverse to the stream has proved a fascinating subject for many decades, with a sequence of studies that have revealed an extraordinarily complicated set of phenomena. In the early days of boundary-layer theory, the cylinder provided a convenient example for demonstrating a boundary layer and its separation on the upstream face. The regular periodicity in the wake flow at Reynolds numbers exceeding about 40 was recognized as a train of vortices that became associated with von Kármán (through his analysis for the vortex spacing). The drag curve, $C_D(R)$, exhibits a big step where transition occurs before separation. A similar step is found in the drag curve of a sphere. For both bodies it was discovered that the Reynolds number of the step is reduced by turbulence in the approaching stream. Before hot-wire equipment became commonplace, the step Reynolds number of a sphere was used to estimate turbulence intensity in wind tunnels. Within the last decade, further evidence of the sensitivity of the flow around a cylinder to disturbances has been found. On the upstream side, the convection of heat is strongly affected by the free-stream turbulence through alterations to the attached boundary layer that are not yet understood (Kestin 1966; Smith 1964). The

fluctuating lift and drag appear to be sensitive also to free-stream turbulence, but through a different mechanism (Gerrard 1965).

Free-stream turbulence is difficult to describe or to control adequately. Some investigators have tried instead to apply simpler disturbances through use of mechanical vibrations or sound fields. Such disturbances can also produce significant effects. When the disturbance frequency is well below the shedding frequency, no effects have been noted, but when the disturbance frequency matches the shedding frequency fairly closely the shedding in the wake tends to become of uniform axial phase (Koopman 1967) and to show changes in fluctuating drag (Bishop & Hassan 1963) and in heat transfer (Kezios & Prasanna 1966).

When the disturbance frequency exceeds the shedding frequency, effects are found if the former matches fairly closely a naturally occurring instability frequency in the separated shear layers (Bloor 1964; Gerrard 1965). Some effects on heat transfer were discovered before the instability frequency itself was detected (Fand & Cheng 1963). The structure of separated shear layers and the influence of vibrations or sound have been studied in other flow geometries, especially the region downstream of a jet nozzle (Michalke 1964*a*; Michalke & Wille 1966, p. 962; Becker & Massaro 1968). Effects of sound have also been studied for attached shear layers (e.g. Knapp & Roache 1968). The disturbances have not all been applied uniformly in these investigations: in some, a travelling sound field has been applied casually, while in others a standing sound field has been used. It is not clear to what extent the fluctuating pressure or the fluctuating velocity is important in producing effects. The evidence is not uniform with respect to the existence of saturation effects. Becker & Massaro, who directed at their jet a travelling sound wave from a loudspeaker, reported that the intensity of the exciting tone had no visible effect above a certain level. Gerrard found a $2\frac{1}{2}$ -fold increase in the fluctuating velocity at the shoulder of a cylinder in cross-flow when a weak travelling sound field ($u'/U = 0.01\%$) was applied at the frequency detected by Bloor, with $R = 6900$. He detected only a slight change when the sound intensity was doubled. Fand & Cheng applied a transverse standing sound field and found that effects on the heat transfer continued to increase with intensity, even though this reached the order of $u'/U = 10\%$.

The increase of heat transfer induced by a sound field is of technological importance. Richardson (1966) pointed out the relationship between Fand & Cheng's results and the flow sensitivity data published subsequently. This relationship is speculative because the mode of influence detected by Gerrard may not persist to high levels of disturbance. The role of this paper is to examine the effects of intense standing sound fields on the flow around a cylinder, to determine whether the suggested relationship is well founded, and to provide insight into the mechanism of heat transfer in separated flows.

2. Details of the experiment

Measurements were performed in an anechoic wind tunnel—an Eckel anechoic chamber that had been adapted to operate as an open jet wind tunnel. Air from a radial fan passed through a heat exchanger and split to pass through two ducts

(containing acoustical silencers) to meet under the floor of the anechoic chamber, as shown in figure 1. The two streams joined after passing through turning vanes (which gave a 2:1 contraction) and passed through fine screens to a second contraction (also 2:1) with a mouth of 14 by 18 in. Initially, a large pulsation in the flow at the fan rotational speed was found. It was necessary to add a pressure drop and flow straightener at the input to the fan as well as individually trimmed flaps on the fan blades to reduce the pulsation.

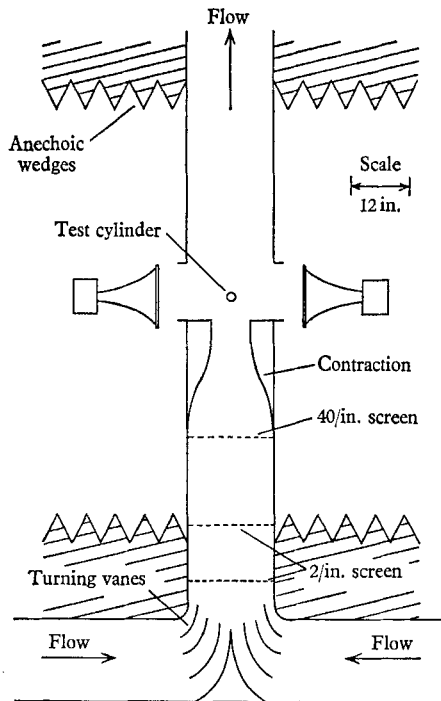

FIGURE 1. Diagram of anechoic wind tunnel.

Although the anechoic chamber is the same one employed by Fand & Cheng, the flow channel differed substantially from the one they used: the turning vanes and contraction were not used in their study. Instead, they relied on several screens to reduce the turbulence resulting from head-on mixing of two input flows in a very small settling chamber and they did not measure their consequent free-stream turbulence. In the present experiments the nominal free-stream oscillation intensity was 0.6%, of which a significant proportion consisted of the residual fan oscillations. The $\frac{3}{4}$ in. diameter aluminium test cylinder contained three heaters and twelve copper-constantan thermocouples; the cylinder ends were mounted in brackets that permitted the cylinder to be rotated about its axis, and the whole assembly was easily demounted from the test section to allow uninterrupted measurements of the sound and velocity fields.

A silicon semiconductor temperature sensor (Kulite type BHO 2000-130), 0.13 in. long, 0.02 in. wide and 0.001 in. thick was attached to the cylinder surface

(oriented with its length parallel to the cylinder axis) with Duco cement diluted with acetone. Leads of number 40 wire were cemented to the cylinder parallel to the axis. The sensor had a resistance of 1947 ohms at 24° C and a sensitivity of 14.8 ohms/degC. It was mounted in a bridge which was balanced at room temperature; the bridge unbalance was taken without frequency compensation of amplitude to a wave analyzer. The cylinder could be rotated to put the sensor in any desired position.

A constant-temperature hot-wire anemometer of Kovaszny design was used in conjunction with a Digitec digital voltmeter. The frequency response was flat past 20 kc, a decade beyond the range of interest.

It takes considerable time to adjust a standing sound field to give maximum uniformity; and for every new frequency the set of horns must be repositioned. The policy followed in the experiments was to make measurements for a set of Reynolds numbers at each of two frequencies, f_a . The set of Reynolds numbers was such that the Bloor-Gerrard frequencies, f_b , spanned the sound frequency. One of the frequencies used matched one used by Fand & Cheng.

3. Flow at the front

The hot wire was supported outside the boundary layer about 60° round from the forward stagnation line. In this position the fluctuations that the wire registers are associated with an irrotational fluctuating flow (determined dominantly by the vortex shedding process) and vorticity fluctuations borne by the free-stream. The latter are relatively weak.

Velocity fluctuation spectra are shown in figures 2 to 5 for four Reynolds numbers and with a transverse sound field applied at 1096 c/s. The spectra for 0 db should be examined first. The first peak (in sweeping from d.c.) corresponds to the fan frequency; the level of this changes only slightly with air speed and is not systematically affected by the sound intensity. The second peak occurs at the shedding frequency. At higher frequencies the velocity fluctuations are very small, though they increase quite rapidly with Reynolds number. There is no trace of velocity fluctuations at the Bloor-Gerrard frequency, f_t . The wave analyzer filter width was set at $\frac{1}{3}$ octave.

The fluctuations at the shedding frequency detected by the hot wire are irrotational fluctuations imposed upon the free-stream flow by the vortex formation process behind the cylinder. Fluctuations in local pressure also occur and have been measured by Gerrard (1961). It is noteworthy that the r.m.s. velocity level (at 0 db) rises quite rapidly with Reynolds number, as was found in the fluctuating pressure measurements.

When a standing sound field is imposed, the signal spectrum includes a distinct peak fairly close in magnitude to the expected value for the sound field; beyond this peak some harmonics were recorded but are probably not originating in the flow over the wire. In two of the traces (figures 3 and 4) at the higher intensity there are small peaks at the subharmonic frequency. As will be seen later, these correspond to conditions which produce a very strong subharmonic content in the signal further downstream; and subharmonic peaks are not seen

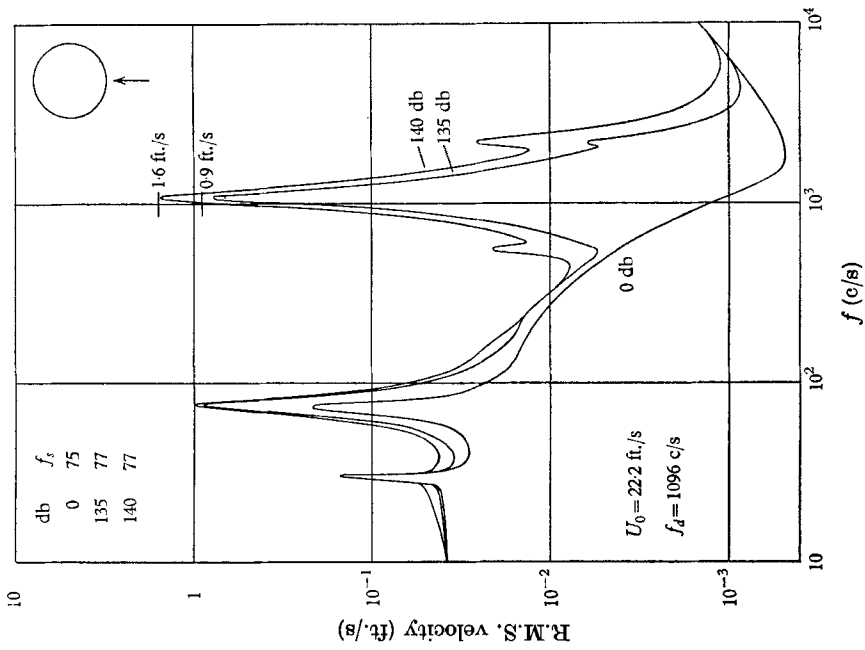

FIGURE 3. Velocity fluctuation spectra, $R = 8160$.

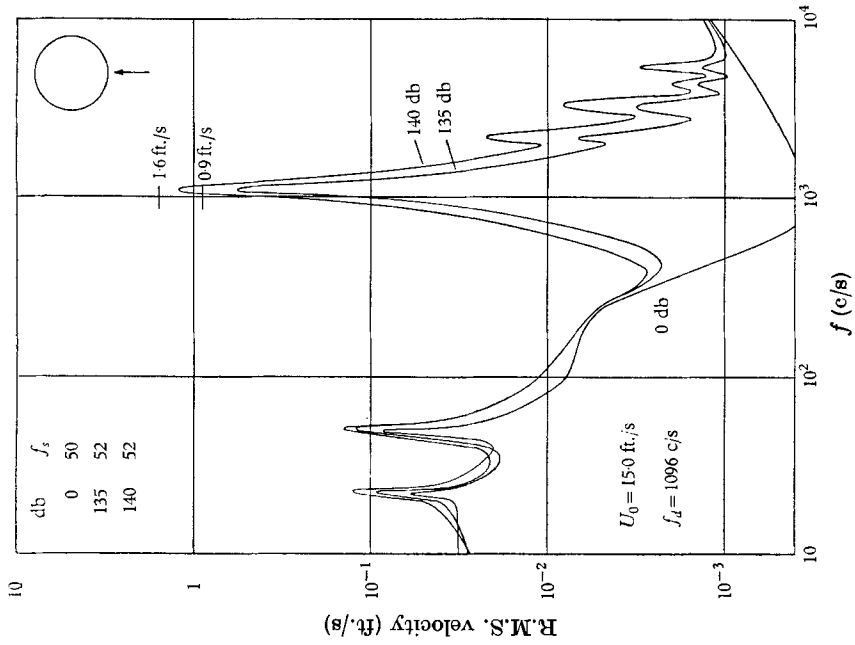

FIGURE 2. Velocity fluctuation spectra, $R = 5520$.

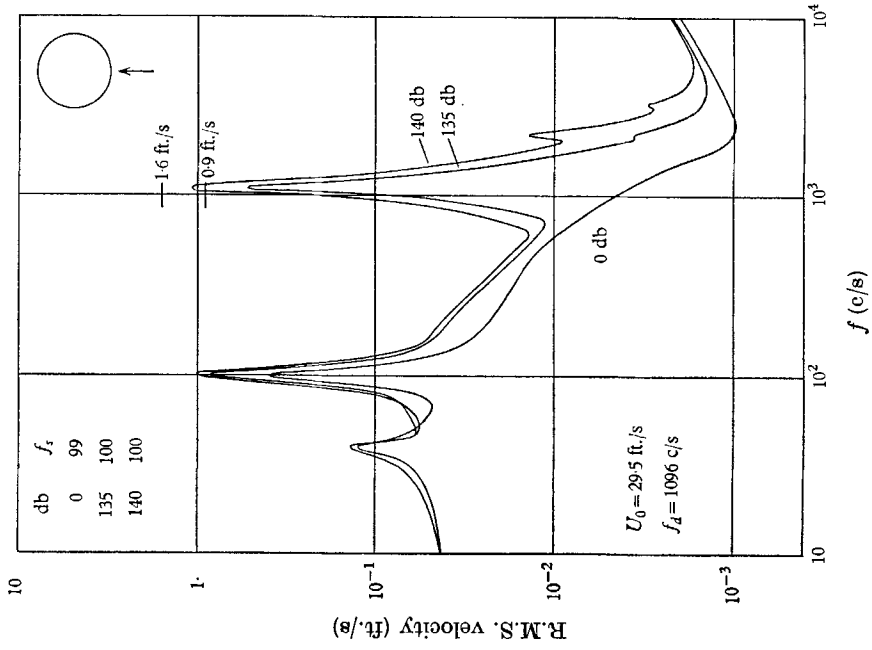

FIGURE 5. Velocity fluctuation spectra, $R = 10870$.

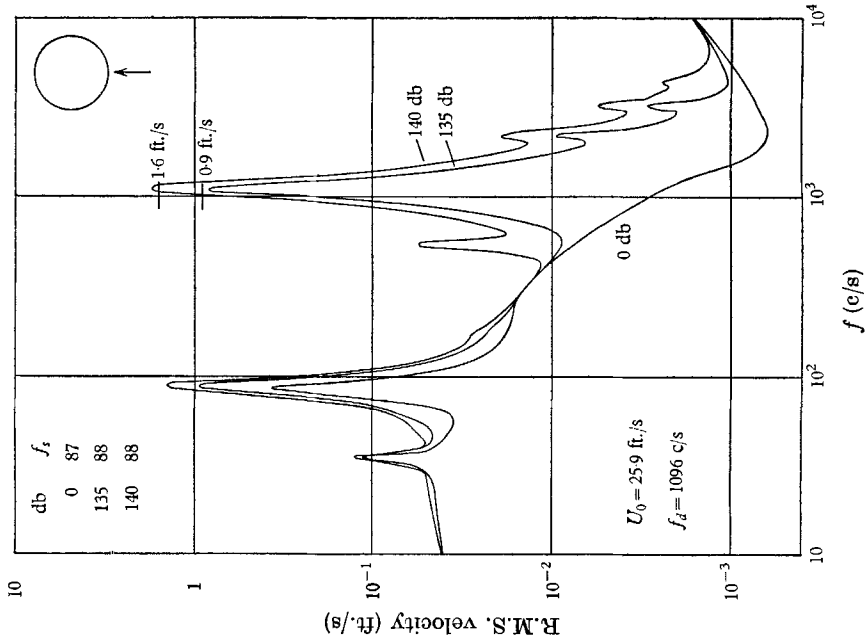

FIGURE 4. Velocity fluctuation spectra, $R = 9530$.

at the front when they are not seen to be strong further downstream. Thus it is probable that the subharmonic fluctuations are present in the flow over the wire.

The dominant and most significant effect in the signal when a standing sound field is imposed is the amplification of the fluctuations at the shedding frequency. This is similar to the effect observed by Gerrard at lower sound intensities; here the amplification is larger than that found by Gerrard.

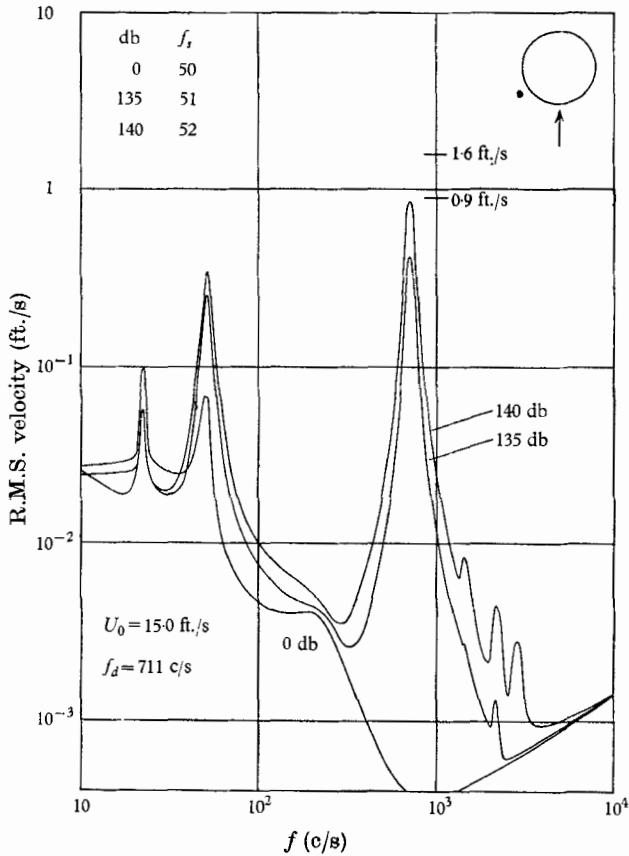

FIGURE 7. Velocity fluctuation spectra, $R = 5520$.

Figure 6, plate 1, shows a matched set of oscilloscope traces of the hot-wire output corresponding to the spectra, figures 2 to 5. These illustrate in particular that when the sound field is applied the fluctuations caused by it are simply superimposed upon the fluctuations at the shedding frequency, the amplitude of the latter being enhanced at the same time. With the sound field imposed at the larger Reynolds numbers there appear to be two intensities possible at the shedding frequency, f_s . This was also reported by Gerrard (1961). The switching from one intensity to another was observed to occur with a relatively long period, the order of one second.

Figures 7-9 display velocity fluctuation spectra for a hot wire in a similar position and for a range of Reynolds numbers which give Bloor-Gerrard

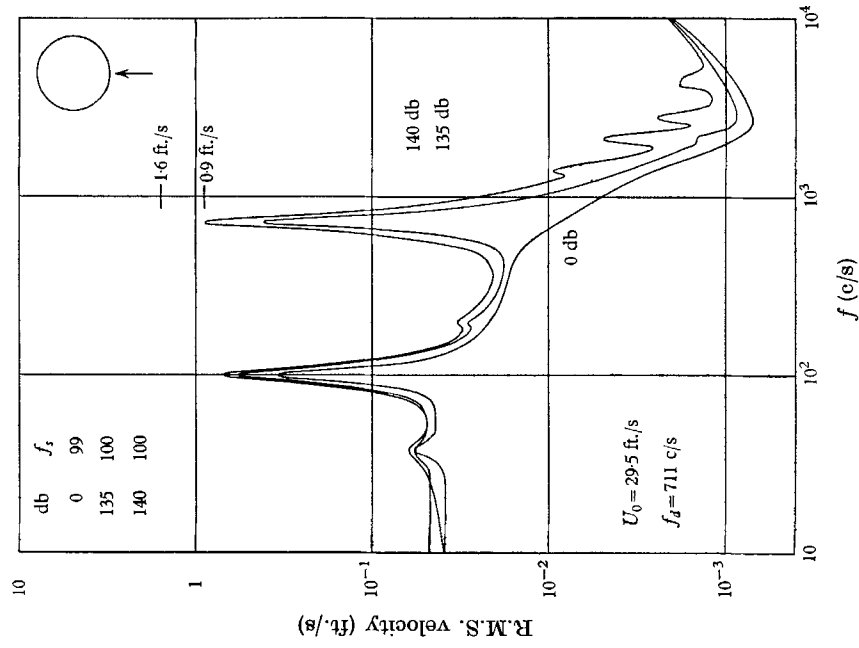

FIGURE 8. Velocity fluctuation spectra, $R = 7350$.

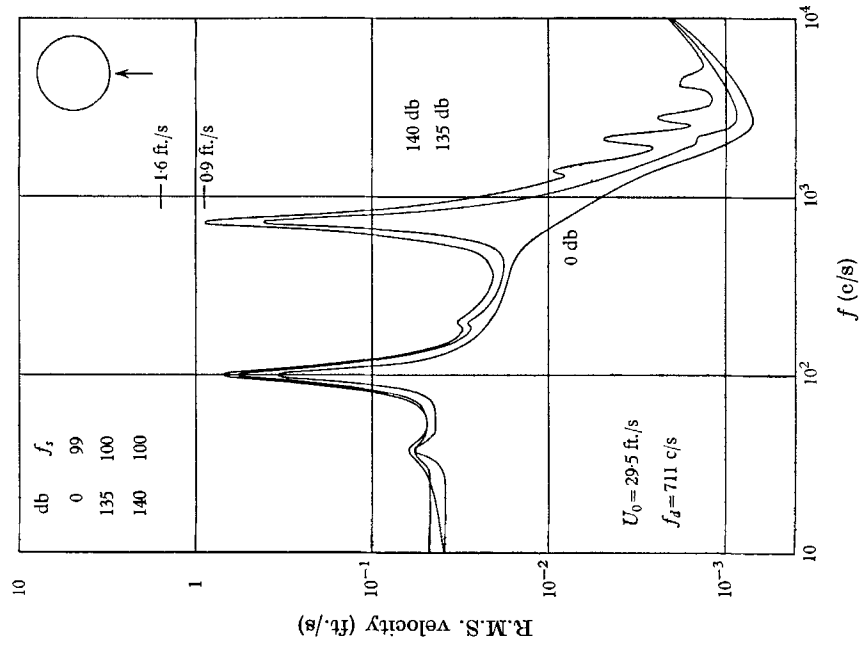

FIGURE 9. Velocity fluctuation spectra, $R = 10870$.

frequencies that span the applied sound frequency of 711 c/s. Similar effects to those found with 1096 c/s occur, except that peaks for the subharmonic are absent.

4. Flow downstream of separation

The hot wire was supported outside the separated shear layer and level with the rear of the cylinder, 1.4 cylinder radii away from the centre plane. This location placed the wire at the edge of the separated shear layer (see Hanson & Richardson's (1968) results for $R = 10,600$). In this position the wire was sensitive to the irrotational fluctuation field from the major vortex formation region and from the separated shear layer itself. On the basis of previous work (Bloor, Gerrard, Hanson & Richardson) it was expected that a strongly periodic flow structure occurred in this region, but with a typical length scale of only a few boundary-layer thicknesses, so that a wire positioned further laterally in the external stream would respond weakly.

Figures 10–13 display velocity oscillation spectra for the same set of flow conditions appropriate to figures 2–5, but for the hot wire in a different position. Again, the spectra for 0 db should be examined first. The first peak (in sweeping from d.c.) corresponds to the fan frequency; and again the level of this changes little with air speed, the value of the peak being essentially the same as that measured by the wire at the front. The second peak occurs at the shedding frequency. (A small peak also occurs at the harmonic of this, particularly at the higher speeds and sound intensities.) At higher frequencies one further peak can be seen which rises in magnitude very rapidly with increase in free-stream velocity. The peak shows some moderate bandspread. The frequency of this last peak matches the Bloor–Gerrard frequency.

When a standing sound field is imposed the signal spectrum again includes a sharp peak at 1096 c/s. It is close in magnitude to the value expected due to the known sound field but this behaviour is more coincidental than at the front, as will be seen when typical oscilloscope traces are examined later. A strong signal is seen at the subharmonic at all Reynolds numbers except the lowest. The spectrum level at frequencies in excess of 1100 c/s is at a much higher level than in the absence of sound. Only a few peaks can be distinguished in this; the spectrum here is essentially a continuum. For figure 12 the applied frequency is very close to that for the last peak of the spectrum at 0 db. Again, a dominant effect seen in the signal when a standing sound field is imposed is the amplification of the fluctuations at the shedding frequency.

Figure 14, plate 2, shows a matched set of oscilloscope traces of the hot-wire output corresponding to the spectra, figures 10–13. Here, in contra-distinction to what was noted from the wire at the front, the fluctuations at the sound frequency are not simply imposed upon the fluctuations at the shedding frequency. For this different hot-wire position, there is a distinct modulation at the shedding frequency, except for the lowest flow speed (figure 10) in which the applied fluctuations do appear as a simple superposition. For this speed there is also no amplification of the signal at the shedding frequency.

Amplitude modulation at the shedding frequency can be seen in the traces

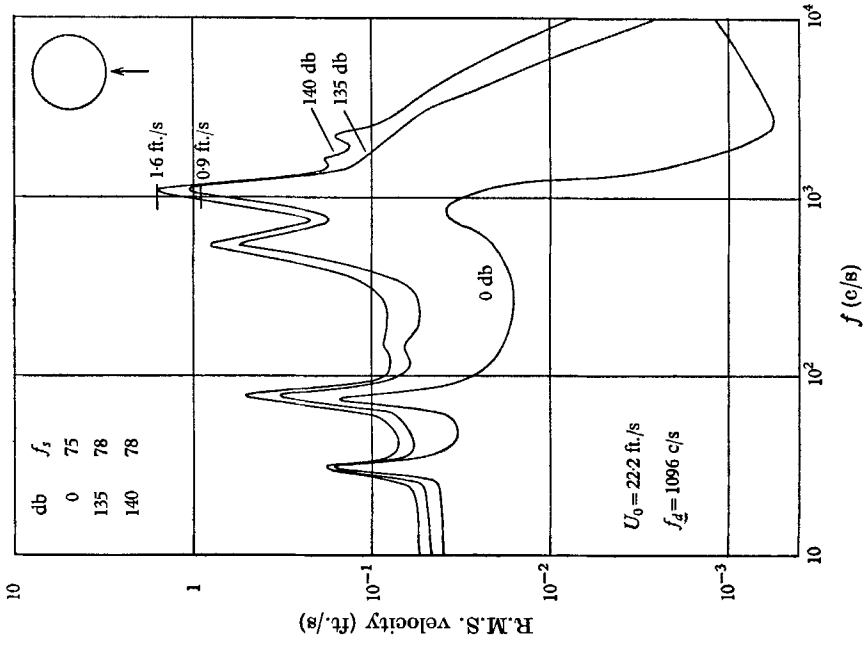

FIGURE 11. Velocity fluctuation spectra, $R = 8160$.

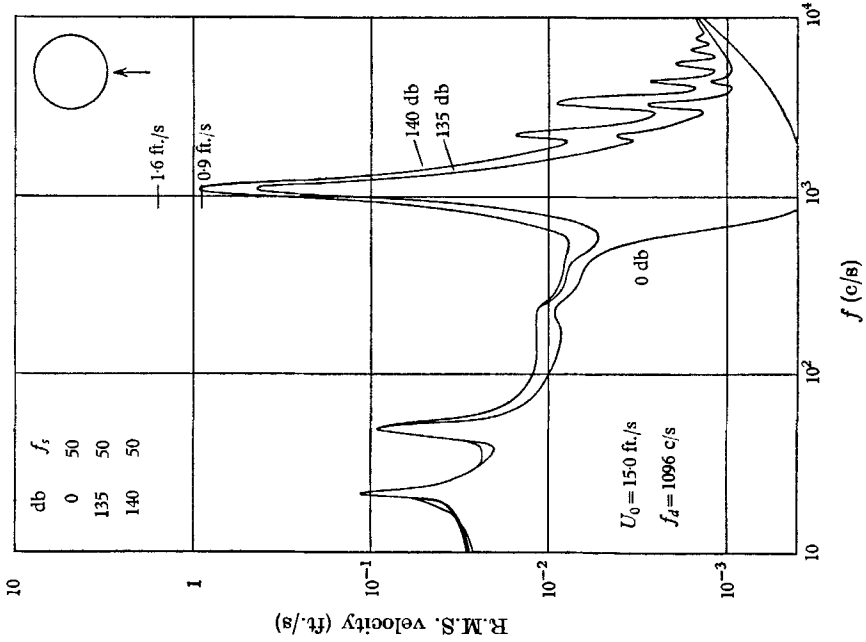

FIGURE 10. Velocity fluctuation spectra, $R = 5520$.

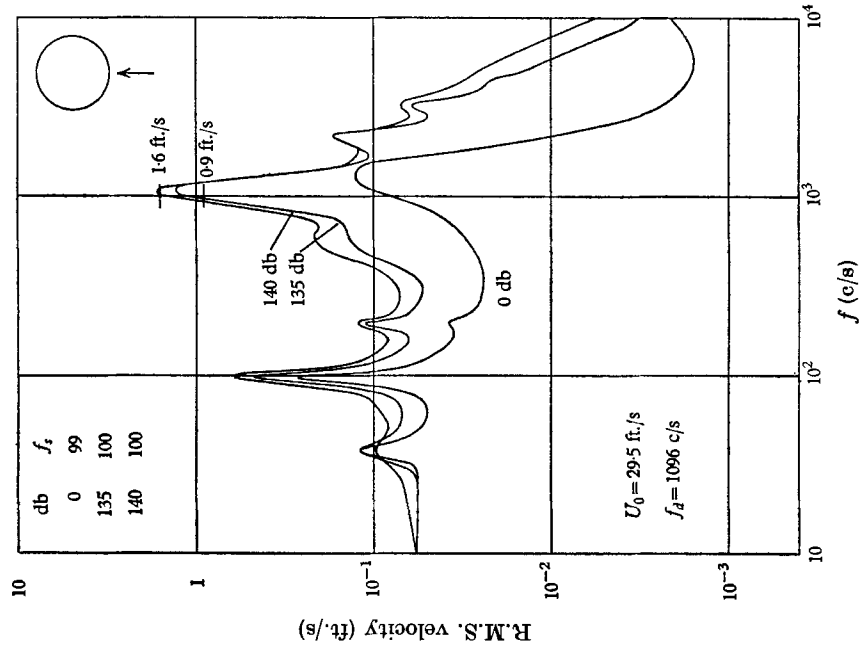

FIGURE 13. Velocity fluctuation spectra, $R = 10870$.

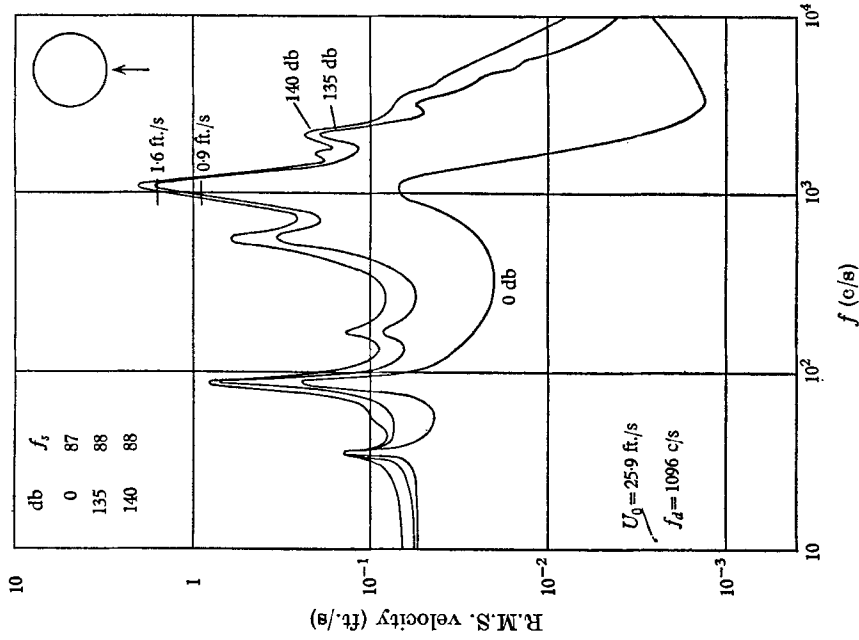

FIGURE 12. Velocity fluctuation spectra, $R = 9530$.

taken at 0 db. The trace for the highest speed also shows a burst of much larger amplitude than seen in neighbouring shedding cycles. The rapid increase in the magnitude of the Bloor–Gerrard frequency peak with increase in Reynolds number, seen in the velocity spectra, corresponds to an increasing frequency of occurrence of such bursts. When a standing sound field is imposed the large-amplitude modulated waves in the signal become more regular. The local amplitude of the oscillation during a shedding cycle can fall regularly below the amplitude associated with the sound field, and (with a different phase in the shedding cycle) can also rise well above it. (The amplitudes given by the sound field without modulation can be seen in the traces at the lowest air speed.) The most natural interpretation of this phenomenon is that the hot wire is sensing the resultant of two sources at the imposed frequency, one source being uniform in time (the imposed sound field) while the other varies in strength and phase but is basically locked into the same frequency. This second source is the separated shear layer. The results for 22.2 ft/s and 25.9 ft./s. can be examined for subharmonic content, bearing in mind that the sound field is always present and uniform. Some traces show that the second source has strong waves occurring at the subharmonic frequency, though these rarely persist distinctly for a whole shedding cycle and they do not show themselves precisely repeatable from one shedding cycle to another. From these traces it becomes clear that the closeness of the velocity spectra magnitudes at the imposed frequency to those of the sound field itself is largely coincidental.

Figures 15–17 display velocity fluctuation spectra for a hot wire in a similar position and for a range of Reynolds numbers which give Bloor–Gerrard frequencies that span the applied sound frequency of 711 c/s. This set of figures correspond to figures 7–9 for flow at the front. Similar effects occur to those found with 1096 c/s, except that the spectrum level at frequencies in excess of that applied was not so noticeably higher than those at the front.

5. Fluctuating heat transfer on the cylinder

The role assigned to the small semiconductor sensor was to detect fluctuations in the heat transfer coefficient locally on the cylinder surface. Results observed by Fabula (1966, appendix G) and Parnas (1965), with low-inertia thermal sensors wrapped completely round cylinders in cross-flow (although at smaller Reynolds numbers than those used here), indicated that it is possible to observe fluctuations at the shedding frequency. An adequate analysis of heated film sensors attached to an unheated substrate has yet to be confirmed in general practical application; the role of conduction in the substrate is recognized in the steady-flow analysis of Tanner (1967) and in the transient studies of Bellhouse & Schultz (1967), who noted that transient conduction in the substrate has an effect on the response even when the film is operated in a ‘constant temperature’ mode (more correctly, the constant resistance mode). The sensor is used differently here: it is essentially a resistance thermometer on the surface of a heated cylinder that has high thermal inertia. However, physical effects that make a precise analysis difficult for the heated film occur also with this style of sensor. Consequently an approximate

analysis is used for interpretation and the results should be regarded as relative measures rather than absolute values.

If there is a fluctuation of the heat transfer coefficient from the surface of the heated cylinder to the fluid flow over it, there is a matching fluctuation in the temperature gradient of the solid at the surface and in the temperature at the surface. The semiconductor sensor measures the spatially averaged temperature fluctuation in a finite thickness from the surface. Because of this finite thickness,

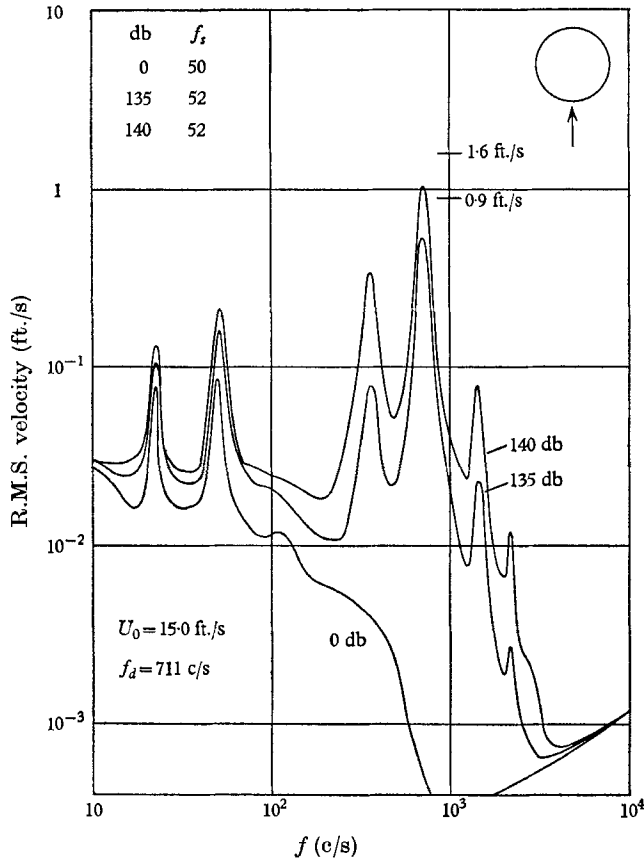

FIGURE 15. Velocity fluctuation spectra, $R = 5520$.

there is a frequency dependent attenuation of the averaged temperature relative to the surface temperature, and also a phase shift. In measuring fluctuation spectra the phase shift is not important but the attenuation is.

A one-dimensional model was used to derive an attenuation correction. The model consisted of a semi-infinite plane slab of aluminium (the material of which the heated cylinder shell was fabricated), having a constant uniform deep-body temperature, with a thin sheet of silicon (the semiconductor material) intimately in contact with its free face. Harmonic variation of the outer surface temperature was considered, and the analysis described by Carslaw & Jaeger (1959) applied

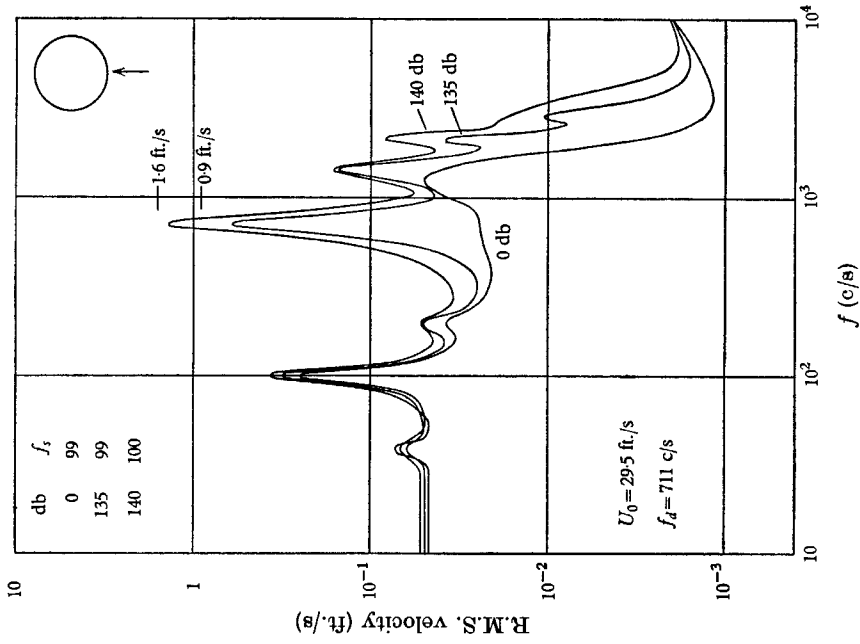

FIGURE 16. Velocity fluctuation spectra, $R = 7350$.

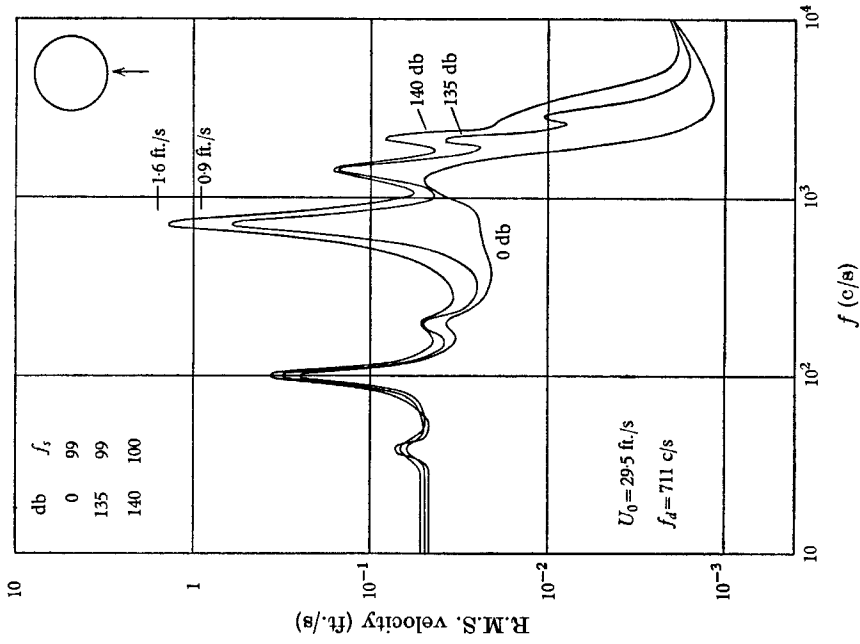

FIGURE 17. Velocity fluctuation spectra, $R = 10870$.

to the composite slab, so that fluctuating temperature measurements from the sheet could be interpreted as fluctuations in the surface transfer coefficient.

Sample spectra of fluctuating heat transfer coefficients are shown in figures 18–20. These were taken with the sensor at the forward stagnation point, 0° , and at 150° , without sound and with a standing sound field of 140 db at 1096 c/s. The line that crosses the charts, rising progressively with frequency, is the noise

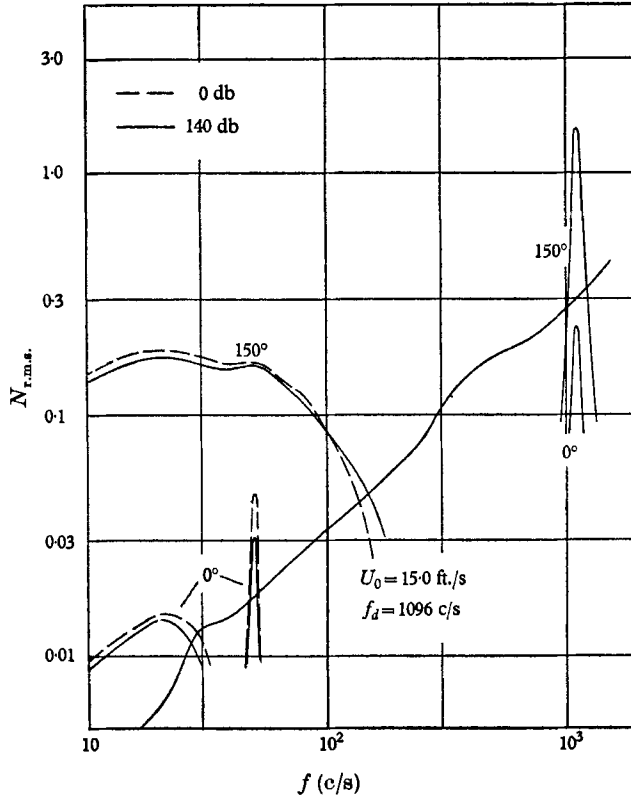

FIGURE 18. Fluctuating heat transfer spectra, $R = 5520$. N based on diameter.

level line, i.e. where $s/n = 1$. Some features are common to these and similarly taken spectra. At 0° and without sound the only distinct peak is at the shedding frequency; there is no peak at the fan frequency even when the hot-wire signals from the wire at 60° show both frequencies in equal measure. At 0° there is a small hump with a maximum near 20 c/s; the magnitude and frequency of this does not increase systematically with air speed. At 150° and without sound there is a maximum at the shedding frequency but with an enormous bandsread around it. When sound is applied, the response at 0° changes by the addition of a sharp peak at the applied frequency (this is also seen at 150°), and if the corresponding hot-wire outputs show amplification at the shedding frequency then the sensor does also. These changes are also seen at 150° , except that amplification at the shedding frequency involves both increase of the fluctuation level in the bandsread, especially at frequencies above shedding, and also the emergence

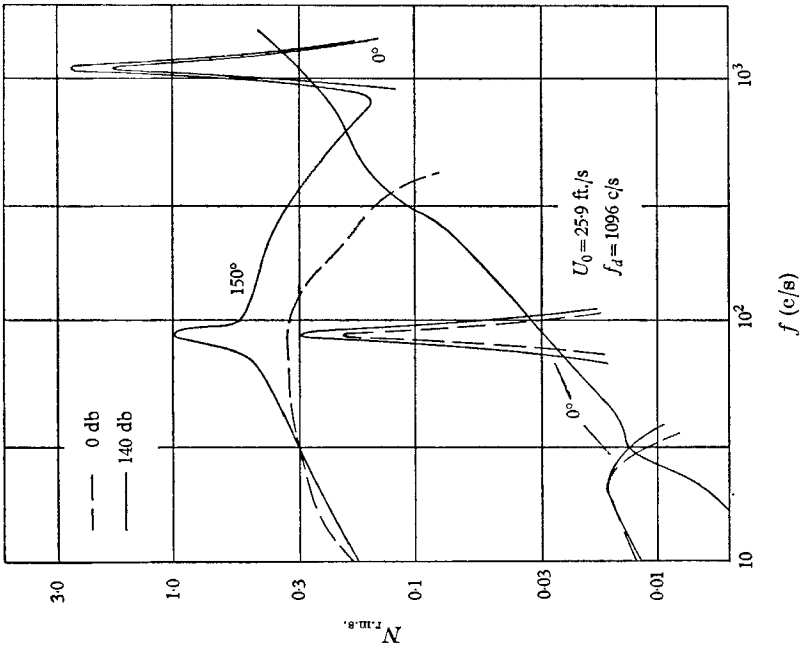

FIGURE 20. Fluctuating heat transfer spectra, $R = 10870$.

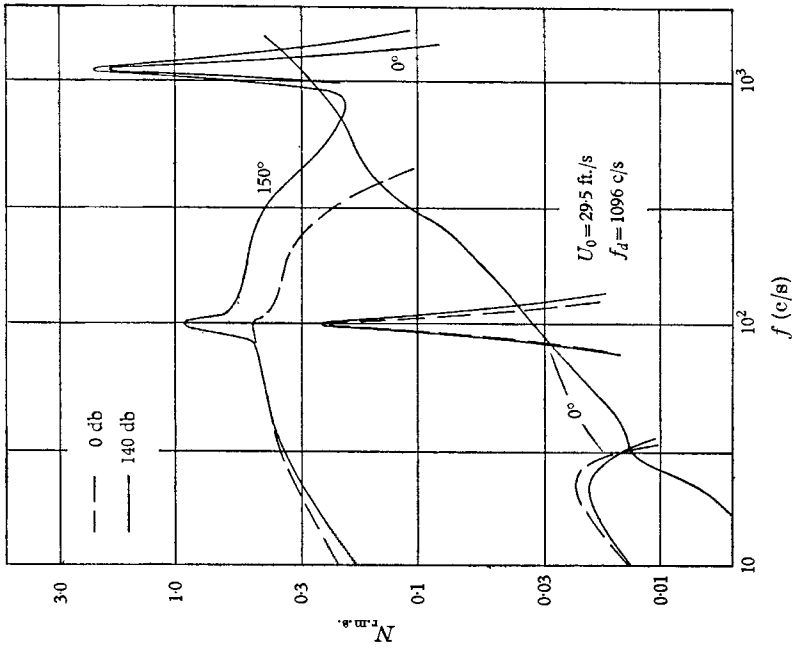

FIGURE 19. Fluctuating heat transfer spectra, $R = 9530$.

of a sharp peak at the shedding frequency above the level of the raised bandsread envelope.

6. Discussion

6.1. *Flow preceding separation*

The measurements in the flow preceding separation of the boundary layer on the cylinder indicate that there are very few disturbances. The principal unsteadiness in the flow consists of oscillations transmitted from the vortex formation region behind the cylinder. These oscillations are transverse, a 'push' on one side being simultaneous with a 'pull' on the other; one effect must be a regular oscillation of the forward stagnation line. The residual pulsations at the fan frequency, by contrast, are spread uniformly through the flow and modulate the amplitude of the flow field rather than change its pattern. Thus it is likely that the fluctuating heat transfer associated with the fan pulsations is of such a low level that it lies well below the noise line for the sensor system, and escaped measurement. The peak at the shedding frequency is sharp, which indicates an absence of turbulence at the front that could cause some bandsread. All the evidence available, including measurements of the free-stream fluctuations, mean heat transfer for the whole cylinder, fluctuating heat transfer, and the hot-wire spectra at 60° , indicate that flow disturbances of the sort that have been found previously to increase forward stagnation region heat transfer are absent here.

6.2. *Flow following separation: the shear layer*

The separated shear layer is unstable. Bloor detected a systematic unstable mode, measuring in particular its frequency from hot-wire oscilloscope traces. Hanson & Richardson (1968) also found this. In the present experiments the spectra showed that the instability frequency is not as sharply determined as the shedding frequency; the instability frequency has a slight bandsread. This is quite common in flows which are not excited with oscillations at a fixed frequency to which an instability frequency may lock. The frequency from the peak in the spectra are compared with Bloor's results in figure 21. The agreement is good, and the existence of the instability must be regarded as well established.

The physical structure of the instability is not so well established. One must inevitably examine other results for instability of separated shear layers besides those observed on a cylinder. A configuration that provides an opportunity for incisive experiments is flow of a jet through a nozzle into quiescent fluid. Some experiments have been performed at significant Mach numbers for studies of jet noise, but others have been made at smaller Mach numbers: among recent work, that accomplished in Berlin (Michalke 1964*a*; Michalke & Wille 1966) and that described by Becker & Massaro (1968) are particularly noteworthy. In experiments, both the Berlin group and Becker & Massaro have obtained photographs of the development of the shear layer instability. This occurs through the formation of vortices in a short train preceding some sort of vortex breakdown in which the vortices become turbulent. Michalke (1964*b*) noted that the instability mechanism associated with velocity profiles having inflexion points, such as

found in wakes and jets, is an inviscid one. Michalke (1965) concluded that the analysis of spatially growing disturbances describes the observed instability properties more precisely, at least for small frequencies. Michalke & Timme (1967) later studied the instability of an axisymmetric model of a vortex formed from a separated shear layer with a view to accounting for the beginning of its breakdown.

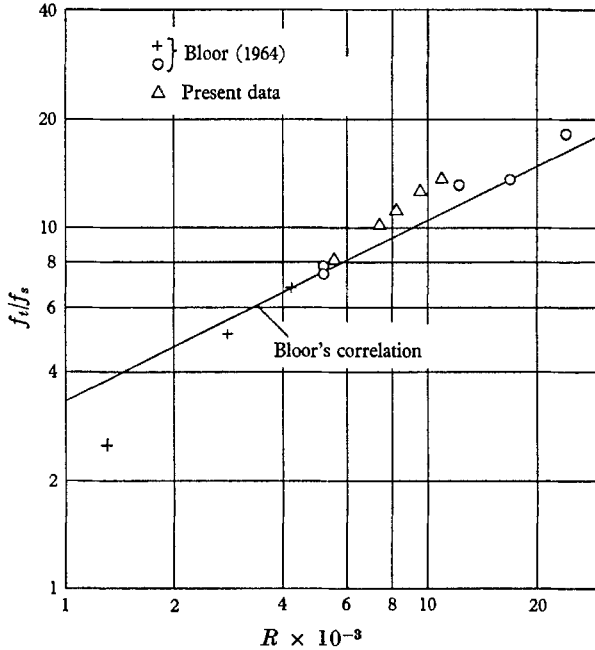

FIGURE 21. Frequency of instability in separated laminar shear layer.

With flow over a cylinder, another frequency also occurs naturally: the shedding frequency. This is well below the instability frequency, and it is possible that the structure of the major vortices forms with evolving vortices (which have their origin in shear layer instability) embedded in it: a sort of frill around the developing major vortex. This complicates the process of interpreting experiments with hot wires. In addition, the separation point on a cylinder is not fixed. The separated shear layer may oscillate somewhat transversely at the shedding frequency. This makes the interpretation of measurements from a hot wire in the close vicinity of the separated shear layer ambiguous. The magnitude of the fluctuations due to downstream passage of perturbations in the shear layer (be these perturbation waves or more developed vortices) varies with phase in the shedding cycle. This could be due either to transverse movement of the shear layer taking the perturbations closer to then further from the hot wire rhythmically, or to actual variations in the state of amplification growth during the shedding cycle.

The level of the fluctuations at the Bloor-Gerrard frequency certainly changes very rapidly with Reynolds number as seen by the hot wire downstream of separation. At its lowest level it may represent only a slight waviness in the shear

layer but with the highest air speed the bursts of larger amplitude possibly correspond to developed vortex structures within the separated shear layer. Of course, nothing of the internal structure of the separated shear layer perturbations can be seen; in the first place, a complete unit passes the hot wire in about 1 ms, for which the display length in figures 6 and 14 is very small, and secondly the internal structure is not capable of producing a strong irrotational fluctuation field outside the shear layer, so that the fluctuation spectra fall rapidly at frequencies above the Bloor-Gerrard frequency.

When a sound field is applied at or near the natural instability frequency the latter locks into it. A corresponding result was obtained by Knapp & Roache (1968) for an attached shear layer. In addition, the amplitude of the perturbation is increased. Becker & Massaro, who directed at their jet a travelling sound wave from a loudspeaker, found that the intensity of the exciting tone had no visible effect above a certain level. They do not state what this level was, but the circumstances of their experiment make it probably below 100 db and possibly much lower. Gerrard (1965) found little effect of doubling his very low sound intensity. In the present experiments effects continue to increase at 135–140 db. It is possible for all these results to be mutually consistent. In the present experiments it is important to remember that the sound field is applied in a particular way: it is a transverse standing sound field with a velocity antinode at the cylinder. It is applied in this way to match the conditions in Fand & Cheng's experiments and because this configuration is efficient for the generation of Reynolds stresses that can enhance convection of heat significantly in the absence of forced flow (Richardson 1967). Of course, the standing wave ratio of the sound field is finite, so that pressure fluctuations are imposed too. However, as the sound field intensity is increased in the present experiment, Reynolds stresses are still generated in the oscillating boundary layer, so that even if no instability occurred in the separated flow some effect on the mean flow would be expected. The relative importance of the pressure fluctuations and the velocity fluctuations could be assessed by creating a standing sound field with a pressure antinode in the plane of the cylinder. It seems important to examine the processes whereby the perturbation amplitude is enhanced in the newly separated shear layer: once the amplitude is not small the continued presence of a fluctuating external disturbance is probably not significant because energy for the growing perturbation is taken from the mean flow field.

The observation of the strong subharmonic in the hot-wire spectra is an interesting result. When it is recalled that the oscillations of the sound field are superimposed upon the component of the hot wire response that comes from the separated shear layer, the considerable strength of the subharmonic in the shear layer is apparent. The probable explanation of the presence of the subharmonic is fusion of neighbouring vortex pairs in the separated shear layer, a phenomenon observed directly by Becker & Massaro. After fusion, the apparent frequency is halved. The fusion process was observed to occur before vortex breakdown. This serves to reinforce the interpretation of the bursts in the no-sound oscilloscope traces (figure 14, highest air speed) as associated with developing vortices before they experience breakdown. Such breakdown may follow fairly swiftly

on vortex fusion, and the high and continuous spectrum, at frequencies in excess of 1100 c/s in figures 11 and 12 with sound applied, is probably generated by vortex breakdown nearby, which enriches the spectrum.

6.3. *Flow following separation: vortex street formation*

It has been demonstrated here that even with very high intensities of applied sound field a progressive influence on the structure in the separated shear layer is possible. It has also been found that this progressively affects the vortex street formation process without changing the vortex street frequency much.

The magnitude of the effect of the sound field on the level of fluctuations at the shedding frequency felt at the cylinder was found to go at least to five times that in the absence of sound. This is larger than the increase detected by Gerrard (1965) with a much weaker sound field, and corresponds more closely to the range of fluctuating lift measurements with which he was making comparisons. Although the sound intensity in the present experiments did not exceed 140 db, Fand & Cheng used intensities up to 148 db and found a progressive increase of effects on heat transfer through this range. The effect on heat transfer appears to occur through influence on the vortex-shedding process, so it is probable that the strength of the latter as felt at the cylinder continues to increase as the sound intensity is increased. The strength of the vortex-shedding process as felt at the cylinder increases with increased regularity of the process and, more particularly, with reduction of the length of the formation region (Bloor 1964; Gerrard 1965). From the available results it appears that the formation region can be reduced in length progressively over a wide range of applied sound intensity.

Gerrard (1967) was able to obtain a realistic shedding frequency from computations using an inviscid model in which separated shear layers were represented as strings of point-vortices of initially uniform spacing. This model left no room for instability of the separated shear layer as discovered here, so that this instability does not appear to have a significant effect on the frequency of shedding. Indeed, the results of the present experiments, which show that the shedding frequency is hardly changed despite major changes in the shedding as felt at the cylinder, attest to the soundness of Gerrard's hypothesis that the shedding frequency is determined by the rate at which circulation is fed downstream from the body, rather than through disturbance effects.

The feature of the vorticity that changes as the sound intensity is increased, at constant Reynolds number, is its spatial distribution. As the intensity is increased with the separated shear layer viewed from a fixed station, the instability becomes more fully developed. The discretization of the vorticity in the separated shear layer is increased. In the experiments performed so far, no distinct evidence has been found of stretching of the vortex cores of the rolls that develop in the shear layer.

The discretization of the vorticity in the shear layer is obviously a function of Reynolds number, because the stability of the shear layer is, also. The role of viscosity is essentially to damp the growth of the unstable mode, as noted by Michalke (1965). Thus we may expect that even in the presence of a disturbance synchronized to the naturally occurring instability the rate of growth of the

instability will be finite and a function of Reynolds number. The effect of the sound field applied in the present experiments is probably first to establish a finite amplitude of the disturbance in the separated shear layer very close to separation; from this beginning level the disturbance grows at some finite rate. The evidence on the evolution of the disturbance on a bluff-body wake is scanty, but it is probably similar to that in a jet shear flow, where the initial waviness develops into distinct rolls that can subsequently incur fusion in pairs and experience vortex breakdown (Becker & Massaro 1968).

A related sequence of events may also account for phenomena observed in the disturbance-sensitive range of Reynolds numbers, such as the large increase in fluctuating lift and drag within about one decade in Reynolds number. At the bottom end of the range the natural amplification rate is low and the separated shear layers persist for a large distance downstream, allowing the formation region to be relatively long. As the Reynolds number is increased the natural amplification rate increases, the shear layer develops a discrete structure, and the formation region is shortened. At the upper end of the range the natural amplification rate is so large that enhancement of this part of the shear layer evolution by disturbances produces only minor variations in the subsequent evolution; and the formation region is very short. One consequence of this sequence is that some variability must be expected in the vortex-formation process at the lower end of the range. It is very unlikely that in the absence of disturbances the separated shear layer will experience exactly the same rate of development of the instability from one shedding cycle to the next; and with different rates of development, different states of discretization will ensue, with consequent fluctuations in the formation region length. It is noteworthy that Hanson & Richardson (1968) observed that there was greater regularity in the vortex formation process at a Reynolds number of 53,000 than at 10,600, a result that agrees with this hypothesis.

6.4. *Flow following separation: heat transfer at the rear*

Heat transfer in separated flows is not well understood. While time-mean measurements have shown a tantalizing regularity (Richardson 1963), the principal details of the convective process remain undetermined. In previous experiments the possible significance of the turbulence intensity in affecting the near-wake of a blunt body through influence on the separated shear layers was not recognized. Simultaneous measurements of heat transfer and fluctuating lift or drag, or vortex formation region length were not made. From the local measurements of Fand & Cheng it is clear that when the amplitude of a matched sound field is increased at constant Reynolds number the heat transfer rate at the rear of the cylinder is also increased. This coincides with reduction of the vortex formation region length. It is possible to show, moreover, that the increase in heat transfer is not due simply to addition of the effects of the Reynolds stresses by the sound field; the increase is too great for that. It is also possible to show that the convection is not due to streaming at the rear of the cylinder induced by the oscillations in the flow there at the shedding frequency.

The measurements of fluctuating heat transfer have maxima at the shedding frequency in all cases examined here, but with an enormous bandspread at the

rear of the cylinder, although no such spread occurs at the front. Fluid is discharged periodically upstream within the vortex formation region, according to flow computations, e.g. Gerrard (1967), Thoman & Szewczyk (1966); this upstream flow can have only a small average velocity (Hanson & Richardson 1968) and it is subjected to strong disturbances. This makes the transit time from formation region to cylinder surface a random variable. In addition, the fluid moving upstream in this way is a matured shear flow, possibly subjected to major stretching in its passage upstream so that its spectral structure would be difficult to estimate based on information now available. The turbulence of this fluid will also contribute to bandspreading.

7. Summary

As a consequence of measurements of flow at the front of a circular cylinder in cross-flow at Reynolds numbers of the order of 10^4 , of the flow downstream of separation, and of fluctuating heat transfer at the front and rear, the following conclusions were drawn and hypotheses advanced: (i) In the absence of significant free-stream disturbance the fluctuating heat transfer at the front occurs at the shedding frequency, and fluctuations in the flow outside the boundary layer also occur at the shedding frequency. (ii) The shear layers that separate from the cylinder surface are intrinsically unstable but the rate of amplification of disturbances is Reynolds-number dependent. (iii) In the absence of disturbances imposed externally, the separated shear layer develops its instability by rolling up into a train of discrete cores. (iv) In the presence of a sound field having its frequency matched sufficiently closely to that occurring naturally in the shear layer, the growth of the instability in the shear layer is enhanced, with the processes of vortex fusion and possibly vortex breakdown being detectable. (v) The frequency of formation of the vortex street is only weakly affected by the artificial enhancement of shear layer instability, at constant Reynolds number. (vi) The vortex formation region length is reduced by the development of the instability in the separated shear layers that interact to produce the vortex street, whether the instability develops more rapidly because of increase in Reynolds number or because of increase in the amplitude of the matched disturbance. This does not imply that application of a disturbance has the effect exactly equivalent to an increase of Reynolds number. The discretization of the vorticity in the shear layers and possibly increased entrainment rates are significant in reducing the formation region length. (vii) Heat transfer at the rear of the cylinder fluctuates at frequencies centred on the shedding frequency. The fluctuation level increases as the vortex formation region shortens. (viii) Heat transfer at the rear is not accountable as laminar convection induced by the flow oscillations at the vortex-shedding frequency or, when sound is applied, as laminar acoustic streaming. The heat transfer is essentially controlled by turbulent motion, with fluid discharged upstream from the vortex formation region being at least partly involved. (ix) Heat transfer from a body under separated flow can be increased if a sound field is applied at a frequency chosen to match an instability frequency natural to the separated shear layer. The most effective

ways of accomplishing this for practical use have not yet been investigated adequately.

The experimental work described here was performed as part of the research programme of heat transfer in unsteady flows of the Aerospace Research Laboratories, Office of Aerospace Research of the U.S. Air Force, under the technical cognizance of Dr Max G. Scherberg. One of us (P. D. R.) was Senior Visiting Fellow at Imperial College, University of London, when this report was prepared. This support is gratefully acknowledged.

REFERENCES

- BECKER, H. A. & MASSARO, T. A. 1968 *J. Fluid Mech.* **31**, 435.
BELLHOUSE, B. J. & SHULTZ, D. L. 1967 *J. Fluid Mech.* **29**, 289.
BISHOP, R. E. D. & HASSAN, A. Y. 1963 *Proc. Roy. Soc. A* **277**, 51.
BLOOR, M. S. 1964 *J. Fluid Mech.* **19**, 290.
CARSLAW, H. S. & JAEGER, J. C. 1959 *Conduction of Heat in Solids*, 2nd ed. Oxford: Clarendon Press.
FABULA, A. G. 1966 Ph.D. thesis, Dept. Aero. Engng, Penn. State Univ.
FAND, R. M. & CHENG, R. 1963 *Int. J. Heat Mass Trans.* **6**, 571.
GERRARD, J. H. 1961 *J. Fluid Mech.* **11**, 244.
GERRARD, J. H. 1965 *J. Fluid Mech.* **22**, 187.
GERRARD, J. H. 1967 *Phil. Trans. A* **261**, 137.
HANSON, F. B. & RICHARDSON, P. D. 1968 *ASME J. Bas. Engng.* **90**, 476.
KESTIN, J. 1966 *Advances in Heat Transfer*, **3**, 1.
KEZIOS, S. P. & PRASANNA, K. V. 1966 *ASME Paper* 66-WA/HT-43.
KNAPP, C. F. & ROACHE, P. J. 1968 *AIAA J.* **6**, 29.
KOOFFMAN, G. 1967 *J. Fluid Mech.* **28**, 501.
MICHALKE, A. 1964a *Ing. Archiv.* **33**, 264.
MICHALKE, A. 1964b *J. Fluid Mech.* **19**, 543.
MICHALKE, A. 1965 *J. Fluid Mech.* **23**, 521.
MICHALKE, A. & TIMME, A. 1967 *J. Fluid Mech.* **29**, 647.
MICHALKE, A. & WILLE, R. 1966 *Proc. Eleventh Int. Congr. Appl. Mech.*, 1964, Munich.
PARNAS, A. L. 1965 Voprosy nestationarnogo perenosa tepla i massy, Inst. teplo- i massoobmena, Ak. Nauk BSSR.
RICHARDSON, P. D. 1963 *Chem. Engng Sci.* **18**, 149.
RICHARDSON, P. D. 1966 *Chem. Engng Sci.* **21**, 609.
RICHARDSON, P. D. 1967 *J. Fluid Mech.* **30**, 337.
SMITH, M. 1964 Ph. D. thesis, Univ. Michigan.
TANNER, R. I. 1967 *Trans. ASME J. Appl. Mech.* **34**, 801.
THOMAN, D. C. & SZEWCZYK, A. A. 1966 *Tech. Rep. Dept. Mech. Engng, Univ. Notre Dame, Indiana.*

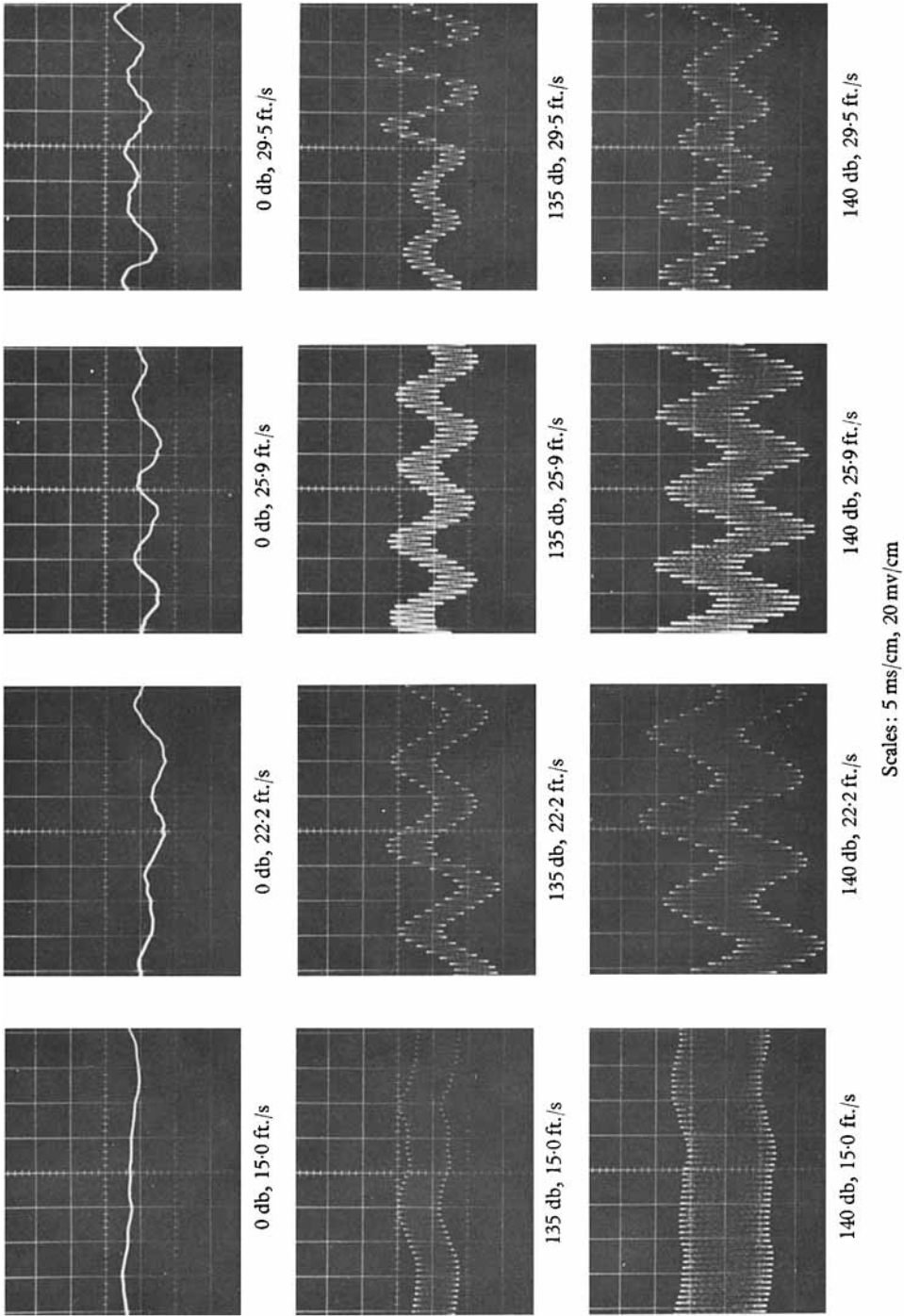

FIGURE 6. Oscilloscope traces for flow near the front of a cylinder with a standing transverse sound field imposed at 1096 c/s.

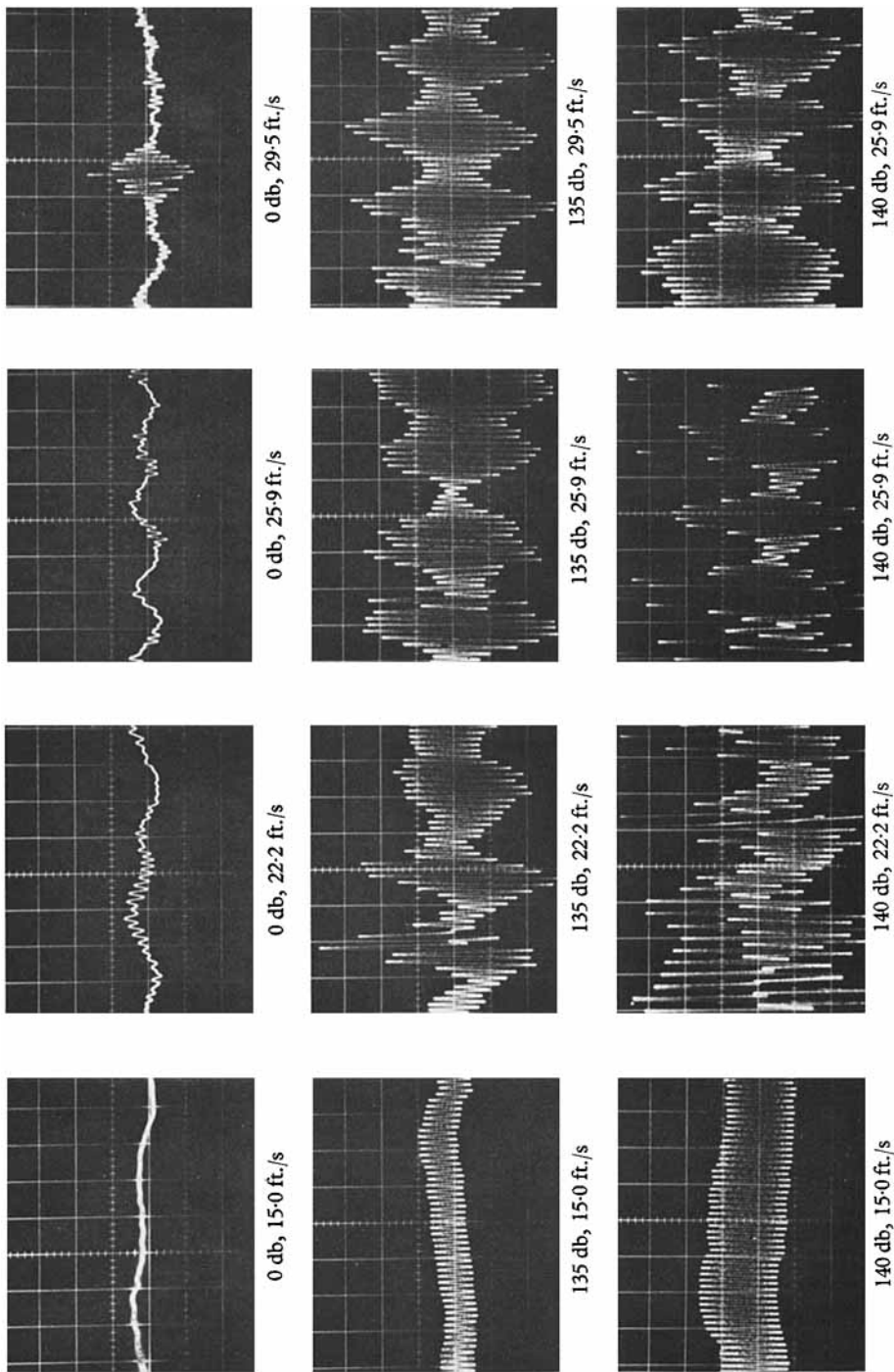

FIGURE 14. Oscilloscope traces for the flow near the separated shear layer with a standing transverse sound field imposed at 1096 c/s.